

Chapter

4

**The Pipe/Soil Structure –
Actions
and
Interactions**

Lester H. Gabriel, Ph.D., P.E.

THE PIPE/SOIL STRUCTURE – ACTIONS AND INTERACTIONS

Composite Structures – Principles of Analysis

Predictability of a structural design's performance is one of many important purposes of structural analysis. Elastic analysis of structures requires that very specific conditions at all points within the structure and on its boundary are satisfied. Forces of action and reaction must be in equilibrium, deformations of adjacent points within and on the boundaries of a structural element must be compatible, and only appropriate stress-strain laws may be employed. If, and only if, displacements of a linear elastic material are small, analysis may be relied upon to be a powerful predictor of performance. Properly designed steel girders experience service displacements of about 0.5%. Corrugated flexible steel, aluminum and plastic pipes experience service displacements of about 5%. The larger the displacement, the less reliable are the predictions.

To enhance performance, structures and structural elements are often designed as composites of multiple materials. Familiar examples include reinforcing bars in concrete and fiberglass filament reinforcement of pressure vessels of thermosetting resins. Both reinforcing materials provide toughness in fields of tension. Steel beam and concrete floor decks, when working as a composite structure of two materials, perform much more favorably than the sum of the capabilities of each. The same is true for a composite structure of pipe and soil. *The buried pipe/soil structural composite requires properly selected and compacted soils surrounding the pipe to reinforce it in a manner that favorably minimizes the pipe's bending stress and maximizes ring compression.* It is the performance of the pipe/soil composite structure that must be predicted by engineering design.

Techniques of structural analysis are complex. For superstructures of buildings and bridges, loads are assigned – most often guided by minimums set by specification. For composite structures – such as buried pipelines, culverts, footings, earth retaining walls, tunnels, mine shafts and subsurface structures – reasonable methods for assigning loads on each element of the composite structure are often incorporated into rational design strategies. The Ring Deflection and Ring Compression theories analyze the performance of the separate elements of the composite after loads are assigned to each. The Burns and Richard and finite element solutions are strategies wherein loads are assigned to the pipe/soil composite. Elastic analysis of surface and gravity embankment loads propagating through an assumed elastic soil medium, and interacting with a pipe of assumed elastic properties, becomes the determinant of loads at the interface between soil and pipe.

Unsupported/Unburied Pipe

Structural Stiffness – Material Response

Stress, an internal ‘force’ response of a deformable body subjected to external forces, is associated with a deformation that excites a strain response. The relationship between stress and strain differs for each and every material.

An elastic material responds to load in a manner that is essentially independent of the time duration of load application, provided that the measure of load is sufficiently small to maintain the integrity of a linear, or nearly linear, stress-strain response. Energy associated with an elastically deformed element is stored (conserved) within the element and, with removal of load, such stored energy is available for complete geometric recovery of the element. The system is called conservative. The assumptions of elastic analysis include a linear, elastic, conservative response with small displacements. Other materials may have an inelastic and/or non-linear response with a time dependency measured in years (concrete is such an example). Still other materials may have an inelastic, non-linear response with a time dependency measured in seconds (plastics make up such a class of materials).

For other than linear, elastic, time-independent materials, departures from the ideal must be accommodated. For plastics, concrete and other non-linear materials, the curvilinear stress-strain response is ‘linearized’ with the use of a secant modulus. At usual levels of working stress, the slope of a proper secant modulus is taken as a close approximation to the tangent of the stress-strain curve (Figure 4-1).

Figure 4-1

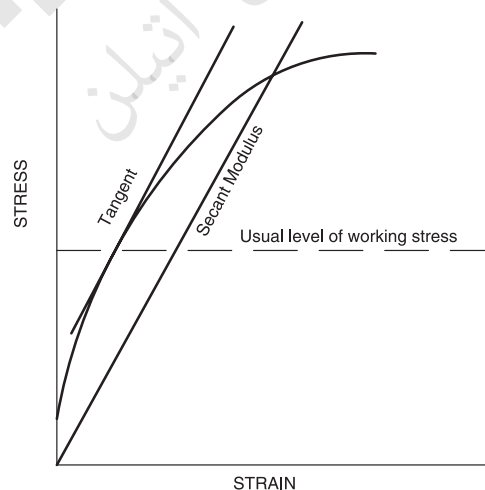

Figure 4-1: Tangent and Secant Moduli

Plastic materials creep with sustained load and do not fully recover during the relaxation phase with removal of load (Figure 4-2). They are non-linear viscoelastic and may be characterized with a creep modulus when the load is maintained, and/or a relaxation modulus when the deformation is maintained. At strain levels approximating those of pipes in service, modular values of creep and relaxation are approximately equal – they decrease with time. See Figure 4-3 for a typical curve of stiffness relaxation, similar to a relaxation modulus, for a solid wall HDPE pipe subjected to a 10% instantaneous displacement.

Figure 4-2

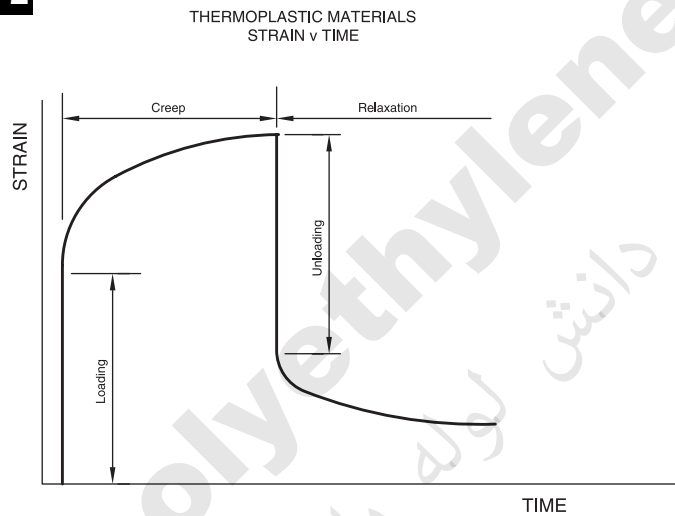

Figure 4-2: Creep and Relaxation

Figure 4-3

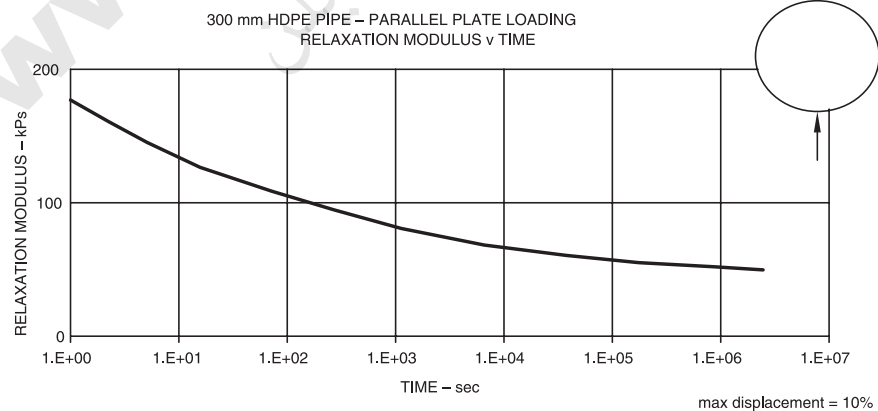

Figure 4-3: Stiffness Relaxation

When restrained at connections, supports and intermediate points, the geometric properties related to the stiffness of a structural element that affect deformation are moment of inertia, area of cross-section and length. These properties, coupled with the nature of end and intermediate restraints, determine the measure and character of a body's internal response to applied forces.

Figure 4-4



Figure 4-4: End Loaded Curved

Reasonable estimates of the measure, character and distribution of loads attracted to pipe and soil can only be judged if the stiffness of each is reasonably well known.

For an elastic material, where time is not a factor:

The stiffness [k] of a structural element responding to an applied force is that force [P] required to cause a unit of deformation [δ] co-linear with, and in the direction of, the applied force.

Therefore: $k = P/\delta$

Equation 4-1

This definition of stiffness (Equation 4.1) works well for materials whose properties are *time-independent*, i.e., materials which do not creep and/or relax in service. For *time-dependent* materials such as plastics, creep and stress relaxation occur; the rate of load application dominates the outcome of the measure of stiffness.

For time-dependent materials, it is useful to redefine stiffness as follows:
(The subscript i indicates that instant following the initial application of load.)

The stiffness $[k_i]$ of a structural element responding to an applied force is that force $[P_i]$ required to cause a unit of deformation $[\delta_i]$ co-linear with, and in the direction of, the applied load force at the instant following the application of load.

Therefore: $k_i = P_i/\delta_i$ **Equation 4-1a**

Thermoplastic materials are not elastic, but rather viscoelastic. Viscoelastic materials exhibit two time-related behaviors: creep and stress relaxation. Creep is increasing strain with increasing or constant stress, the latter a condition witnessed in the laboratory. It causes flexible pipe to deflect under soil load until the pipe/soil composite structure essentially stabilizes. Stress relaxation is decreasing stress with increasing or constant strain, the latter occurring to the stabilized soil/pipe composite. Both creep and stress relaxation are initiated at the instant of load application. Stress relaxation prevents stress levels from remaining at extremely high levels, and thus plays a very beneficial role in buried pipe behavior.

For unburied or unsupported pipes of elastic materials, and for unburied or unsupported pipes of plastic materials, at the instant of application of load as shown in Figure 4-5, the relationship between load and deflection is given by:

Figure 4-5

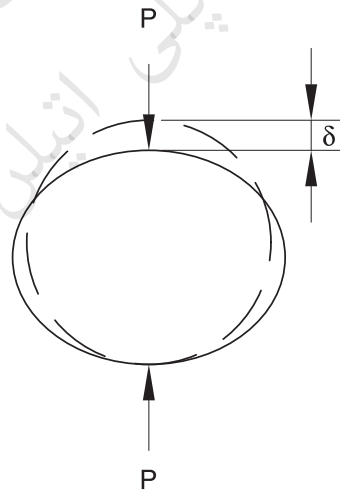

Figure 4-5: Two-Point Load

$$\delta = \frac{0.1488WR}{EI} \propto \frac{W}{(E)(I/R^3)} \quad \text{Equation 4-2}$$

$$\delta = \frac{\text{load}}{(\text{material stiffness})(\text{geometric stiffness})} \quad \text{Equation 4-2a}$$

Where:

- δ = deformation
- P = force
- R = effective radius of pipe
- E = modulus of elasticity
- I = moment of inertia of the wall profile

Identifying the denominator in Equation 4-2a as the composite stiffness, k, Equation 4.1 is obtained with rearrangement of terms. Knowledge of the pipe's material stiffness properties alone is insufficient for the prediction of the performance of the pipe part of the soil/pipe composite structure. Properties of geometric stiffness must also be known.

Parallel Plate Test

Included as part of ASTM D 2412, *Test Method for Determination of External Loading Characteristics of Plastic Pipe by Parallel Plate Loading*, is the application of two loads, at the opposite ends of a diameter, equal in magnitude, opposite in direction and co-linear. There is no pattern of loading that will excite greater moments at crown, invert and springlines – and lesser ring compression throughout – than that shown in Figure 4-5. Therefore, the test is not representative of a typical installation and is not accurate for predicting field performance.

Curved Beam Test

The Curved Beam Test (CBT) of HDPE pipe, more closely than the parallel-plate test (ASTM D 2412), approximates service conditions. The curved beam arc section, cut from the circular sections of manufactured pipe and loaded as shown in Figure 4-4, includes a greater proportion of ring compression than that which is present in the parallel plate test on the full circular cross-section when loaded as shown in Figure 4-5.

Pipe stiffness at the instant of load application, a time-independent stiffness, is preferred for the following reasons:

- The load at the time of placement dominates the final displacements.
- At the instant of application of load, small deflection theory has not been violated.
- At the instant of load application, load relaxation has not interfered with the estimate of stiffness.

In thermoplastic materials, in general, and in HDPE, in particular, the stress relaxation is very rapid in the beginning. Figure 4-6 is the load-time curve for a curved beam cut from a 48 in. (1200 mm) profile wall HDPE pipe and subjected to a nearly instantaneous (approximately 3/4 of 1 second) 5% shortening of the vertical chord connecting the end points of the curved beam, *as shown in Figure 4-4*. When the deflection is held constant, 20% of the load has attenuated in slightly over 2 seconds. After one day, only 30% of the initial peak load maintains the 5% deflection and equilibrium of forces.

Figure 4-6

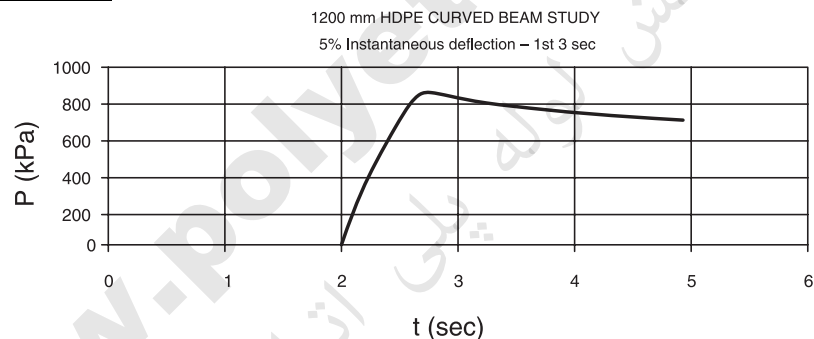

Figure 4-6: HDPE Curved Beam Study

Buried/Supported Pipe

Interaction of a Soil Envelope with a Flexible Pipe

Flexibility in buried pipes is a desired attribute. Understanding how the flexible pipe relates to its neighboring soil – thereby establishing a functional pipe/soil composite structure – is key to successful design.

A buried pipe and its adjacent soil elements will attract earth embankment loads and live loads in accordance with a fundamental principle of structural analysis: *stiffer elements will attract greater proportions of shared load than those that are more flexible.*

This principle is illustrated in Figure 4-7 where, given the same well-compacted soils surrounding the pipe, the more flexible pipe attracts less crown load than the rigid pipe of the same outer geometry. The surrounding soil is of greater stiffness than the flexible pipe and of lesser stiffness than the rigid pipe. For thermoplastic flexible pipe, soil stiffer than the pipe settles less than the pipe displaces, thereby permitting development of soil abutments, a necessary condition for the formation of a soil “arch.” A second necessary condition is realized when the (intergranular) shear strength of properly compacted soil some distance above the pipe is mobilized to maintain its geometry. The earth load on the crown of the pipe culvert is the portion between the crown and some effective location of the soil arch (shown schematically by the dashed lines). This load is less than the prism load – a rectangular prism of earth extending from the top of the culvert surface to the top of the embankment, with a base exactly the width of the outer dimensions of the culvert (shown schematically by the dotted lines).

For the rigid structure, the more compliant soil adjacent to the pipe settles more than the pipe decreases in height. The shear resistance provided by the soil contacts results in an earth “pillar” (shown schematically by the dashed lines in Figure 4-7), attracting a load greater than the prism load.

Figure 4-7

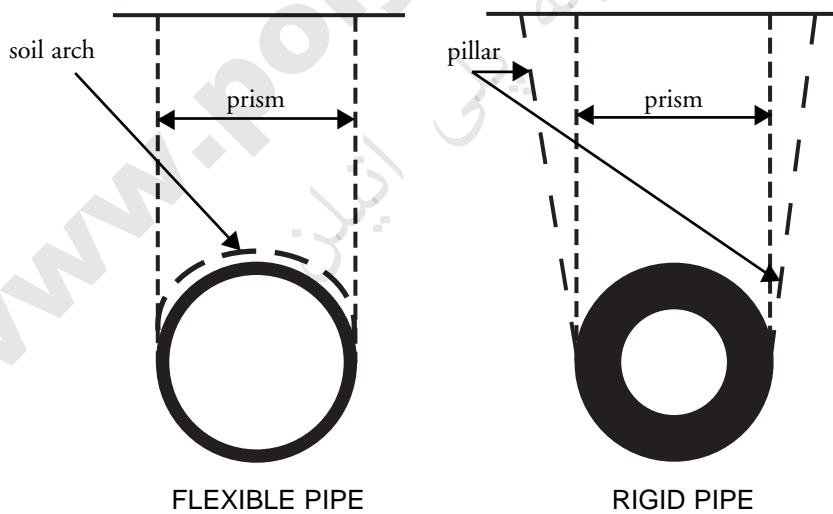

Figure 4-7: Crown

To maximize the opportunity for stress relaxation in a bedded pipe (and simultaneous transfer of load from pipe to soil) – and for creep to be negligible – control of the selection, placement and compaction of backfill is essential. In a properly designed and constructed flexible pipe/soil composite, the stiffness of the soil will be substantially greater than the stiffness of the pipe.

The attributes of pipe flexibility in a pipe/soil composite structure are manifested in many ways. Proper installation will insure the following advantages:

- Denser soil at springline favors the development of more competent ‘abutments’ necessary for the development of a soil arch. Less dense soil immediately above the crown also favors the development of a soil arch. The presence of a competent soil arch reduces the proportion of gravity loads attracted to the pipe (Figure 4-8).
- Denser soil at springline favors the development of lateral passive pressure. Greater lateral passive pressure gives rise to moments, shears and displacements opposing those that exist in the pipe in response to gravity loads only.
- When a flexible pipe laterally elongates and vertically shortens in response to gravity loads, it adds density and stiffness to the soil in the vicinity of springline and reduces soil density and stiffness in the vicinity of the crown. This results in a lesser proportion of prism load than would otherwise be attracted to the crown. The vertical arching factor (VAF) is the parameter that quantifies the proportion of prism load interacting with the crown (see Chapter 5).

Figure 4-8

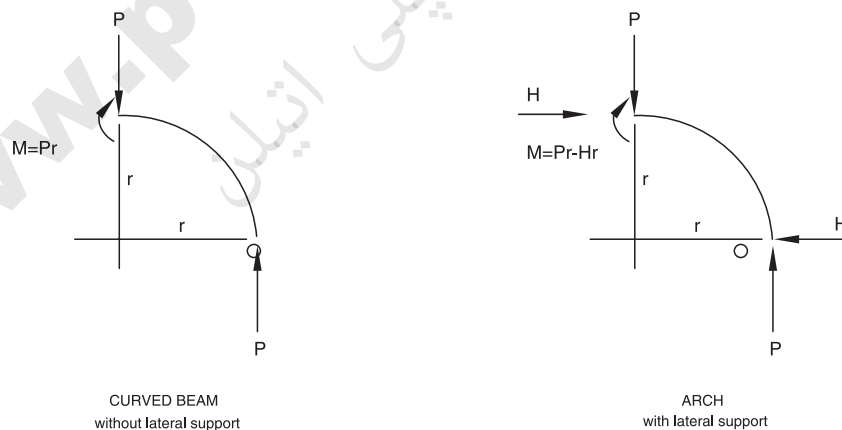

Figure 4-8: Benefit of Springline Support

All of these interaction effects occur simultaneously and enhance the stability of the composite structure.

Stress Relaxation and Creep

Creep in thermoplastic materials is a complex relationship between strain and time. Where pressure loads occur in pipelines (e.g.; gas, water), hoop (ring) tension is the pipe's response. When the internal pressure is relieved, the hoop tensile stress will relax – but not immediately and not completely. If internal pressure is sustained, creep occurs and the associated hoop tension may cause ductile tearing, brittle fracture, neither or both. The time to any creep failure varies inversely with the magnitude of sustained stress.

Except for very shallow burial, the response of a non-pressure gravity flow drainage pipeline is dominated by the external soil loads. For sustained loads, with stress relaxation and the resulting attenuation of the pipe's bending and ring residual material stiffnesses, load is transferred to the stiffer soil of the pipe/soil composite structure. This additional load in the soil results in some adjustment of the soil envelope, including the further development of lateral pressure in the vicinity of springline. This increase in lateral pressure counteracts the bending due to gravity loads, and the result is a further increase in ring compression. When attenuating relaxation of pipe stiffness results in negligible transfer of load to the soil, the forces at the pipe/soil interface and displacement of the composite pipe/soil structure become essentially fixed and stable.

Studies by Howard and Janson confirm that in poorly compacted soils, final pipe deflection after two to three years is more a function of change in soil stiffness than stress relaxation of the pipe material, an additional argument for proper soil and proper compaction of the soil envelope.

Influence of Profile Wall Geometry

An important property of a flexible pipe is that it has the ability to adjust its geometry in a manner that reduces internal resisting moments in favor of increased ring compression. Greater ring compression and lesser bending result in lower net tension or none at all, a favorable outcome. Within constraints of handling, shipping and storage, the greater the flexibility, the more efficient the in-service performance of buried pipes. Studies have shown that the flexural stiffness may be disregarded in favor of studying only the hoop response with little lost accuracy in analytical predictions. A properly bedded flexible pipe gives rise to reasonably predictable passive soil forces in the vicinity of springline.

Production line pipes of the same nominal diameter – manufactured from identical HDPE material specifications and of equal pipe stiffness (as defined by ASTM D 2412) but of different wall profile geometry – perform differently under similar soil loading. Laboratory studies confirm that the geometry of the wall profile greatly influences the response of the pipe.

Application to Thermoplastic Non-Pressure Drainage Pipes

AASHTO's Section 18 includes recommendations of measures of mechanical properties for design of HDPE and PVC gravity drainage pipes including initial and 50-year elastic moduli. After 50 years of sustained load (not necessarily the age of the installation or pipe), the prescribed minimum modulus of elasticity is reduced by 80% for HDPE and 65% for PVC. Interface pipe/soil loads of interaction are diminished as relaxation of the pipe material and, to a lesser extent, the soil occurs. Furthermore: "Minimum 50 year moduli do not indicate a softening of the pipe material but is (sic) an expression of the time dependent relationship between stress and strain. For each short term increment of deflection, whenever it occurs, the response will reflect the initial modulus."

The moduli of elasticity of AASHTO Section 18 are defined by tests of centrally located loads on simply supported beams, applied at 12.5 ± 0.5 mm/min. They are evaluated as secant moduli (Figure 4-1) at 2% strain. Bending is the dominating response; axial compression is absent. In many time-independent engineering materials, flexural compression and axial compression moduli are close in value. For purposes of design, they often are assumed to be the same. However, ring compression is likely to dominate the stress response of flexible pipes buried in a stiffer soil mass. AASHTO Section 18 does not address a ring compression modulus. But for purposes of design and predictions of performance, modular values of beam flexural compression are used for ring compression calculations.

Bibliography

American Association of State Highway and Transportation Officials, *M 294 Corrugated Polyethylene Pipe, 300-to-900 mm Diameter*.

American Association of State Highway and Transportation Officials, *M 304, Poly (Vinyl Chloride) (PVC) Profile Wall Drain Pipe and Fittings Based on Controlled Inside Diameter*.

American Association of State Highway and Transportation Officials. Section 18. *Soil-Thermoplastic Pipe Interaction Systems*. Standard Specifications for Highway Bridges.

ASTM Standards, *D 2412. Test Method for Determination of External Loading Characteristics of Plastic Pipe by Parallel Plate Loading*.

Howard, Amster K., *Load-Deflection Field Test of 27-inch (675-mm) PVC (Polyvinyl Chloride) Pipe*, Buried Plastic Pipe Technology, ASTM STP1093. 1990, pp. 125-140.

Janson, L.E., *Short-term versus Long-term Pipe Ring Stiffness in the Design of Buried Plastic Sewer Pipes*, Proc. Int. Conf. Pipeline Design and Installation, ASCE, Las Vegas, 1990, pp. 160-167.

McGrath, Timothy J., *Calculating Loads on Buried Culverts Based on Pipe Hoop Stiffness*, Transportation Research Board, 1999 Annual Meeting, p. 10.

Moser, A.P., *The Structural Performance of Buried 48-inch Diameter N-12 HC Polyethylene Pipes*, Utah State University, Logan, Utah 1994.

Notes

www.polyethylene.ir
دانشگاه فوله پلی اتیلن